

Contents

	Page
Contents/ Introduction	1
Important Safety Instructions	2
Radius 45	3
Radius 90	4
Radius 180	5
Radius 45/90/180 Wall Bracket Fixing	6
Radius 225	7
Radius 250	8
Radius 225/250 Wall Bracket Fixing Instructions	9
Radius 270	10
Radius 360 & Radius 720	11
Fine Tuning & Trouble Shooting the Radius 360 & 720	14
System Wiring Configurations	15
Ancillary Equipment/ Guarantee & Service	16
Claims Under this Guarantee	17

Introduction

Congratulations on purchasing Monitor Audio loudspeakers. We are confident they will provide a reliable, high performance sound for many years as only quality components have been used throughout.

Monitor Audio are a highly respected member of the 'Guild of Master Craftsmen' with over 30 years of experience in the art of traditional wood working techniques and leading edge drive unit technology. This blend of experience and technology brings you the Radius Series.

Please follow this user manual carefully as it contains important information about positioning and set up procedures. **For further advanced information on system set-up, FAQ's and multi-lingual support please refer to our website at: www.monitoraudio.co.uk**

Important Safety Instructions

1. **Read these instructions.**
2. **Keep these instructions.**
3. **Heed all warnings.**
4. **Follow all instructions.**
5. **Do not use this apparatus with water.**
6. **Clean only with a dry cloth.** Great care and attention has gone into the materials chosen to produce the Radius loudspeakers. A gentle wipe with a dry, clean cloth is all that is required to remove any dust. Treat them as you would a fine piece of furniture because that is how they have been designed.
7. **Do not block any ventilation openings.** Install in accordance with the manufacturers instructions.
8. **Do not install near any heat source,** such as radiators, heat registers, stoves, or other apparatus (including amplifiers) that produce heat.
9. **Do not defeat the purpose of the polarised or grounding type plug.** A polarised plug has two blades with one wider than the other. A grounding type plug has two blades and a third grounding prong. The wider blade or the third prong are provided for your safety. If the provided plug does not fit your outlet, consult an electrician for replacement of the obsolete outlet.
10. **Protect the power cord** from being walked on or pinched particularly at plugs, convenience receptacles, and the point where they exit from the apparatus.
11. **Only use attachments/ accessories specified by the manufacturer**
12. **Use only with** the cart, stand, tripod, bracket, or table specified by the manufacturer or sold with the apparatus. When a cart is used, use caution when moving the cart/ apparatus combination to avoid injury from tip-over.



13. **Unplug this apparatus** during lightening storms, or when unused for long periods of time.
14. **Refer all servicing to qualified service personnel.** Servicing is required when the apparatus has been damaged in any way, such as power supply cord or plug is damaged, liquid has been spilled or objects have fallen onto the apparatus, the apparatus has been exposed to rain or moisture, does not operate normally or has been dropped.
15. **This apparatus shall not** be exposed to dripping or splashing water and that no object filled with liquids such as vases shall be placed on the apparatus.
16. **This exclamation point** within an equilateral triangle is intended to alert the user to presence of important maintenance (servicing) instructions in the literature accompanying the appliance.



RADIUS 45

Positioning

The Radius 45 can be positioned on a shelf by fitting the rubber feet provided to the underside of the speaker to stop vibrations. Alternatively, you can choose to fix the Radius 45 to a wall by using the high-quality metal alloy wall bracket provided. A specially designed Floor Stand can be purchased from your local authorised Monitor Audio dealer for placement in free space (available soon). To fix your speaker to the wall when using the wall bracket, please refer to the 'Wall Bracket Fixing Instructions' in the wall bracket carton.

Configuration

The uniquely designed, ultra compact Radius 45 has been primarily designed as a satellite speaker for use in a multi-channel audio or video system. Combined with the Radius 360/720 subwoofer, the Radius 45 forms an extremely discreet system that can be wall or stand mounted to fit in with a modern lifestyle environment. The rear firing gold C-CAM tweeter is able to spread the sound around the room to create a wide sound-stage, giving the apparent performance of a much larger speaker system. Please refer to the section; 'System Wiring Configurations' on page 15. **NOTE:** When used with an A/V receiver amplifier or processor the speaker setting should be set to 'small' and the crossover frequency set to 120Hz. If the receiver only has a 80/100 Hz setting it must be noted that the overall power handling and maximum sound pressure level will be reduced.

NOTE: The Radius 45 is fitted with a PTC device. This protects the drive unit and tweeter from being over driven. The PTC is a thermal device. When too much current is passed through it, it gets hot and trips out. If the sound should suddenly cut out, please turn your system off and allow the PTC to cool down. After a short while you can then turn your system back on again. If the PTC does trip, turn the volume down slightly to help prevent it happening again.

Grille Fitment

To help the Radius 45 fit into any life-style environment we include a choice of silver and black grilles (silver and white with white Radius 45) as standard. You will find the spare grille enclosed within the polystyrene packaging end caps.

If you wish to change the grille colour, you can do this by carefully removing the grille, using your fingers to gradually pull the existing grille off the cabinet. To fit a grille, ensure the badge is correctly orientated and gently press the grille into place.

Technical Specification

Frequency Response	Nominal Impedance	Sensitivity (1w@1m)	Maximum SPL	Power Handling Full Range (R.M.S)	System Power Handling (R.M.S)	Recommended Amplifier Requirements
120 Hz – 22 KHz	8Ω	87dB	101dBA	25W	50W	5-25 W

Bass Alignment	Drive Unit Complement Bass	Drive unit Complement Tweeter	External Dimensions (cm)	Weight Kg (each)
Sealed Cabinet	1 x 3" MMP 2 (Second generation metal matrix polymer)	1 x 20mm C-CAM gold dome tweeter. Rear firing.	9.5 H x 9.5 W x 9.5 D	0.95

RADIUS 90

Positioning

The Radius 90 can be positioned on a shelf by fitting the rubber feet provided to the underside of the speaker to stop vibrations. Alternatively, you can choose to fix the Radius 90 to a wall by using the high-quality metal alloy wall bracket provided, or by purchasing the specially designed bespoke Radius Floor Stand from your local authorised Monitor Audio dealer. To fix your speaker to the wall, please refer to the 'Wall Bracket Fixing Instructions' in the wall bracket carton. When using the wall bracket, we do not recommend connecting the loudspeaker using 4mm plugs into the ends of the terminals. Instead the connection can be made by unscrewing the terminal cap and using the through hole. The terminal cap can be retightened to provide a secure connection.

Configuration

The Radius 90 is extremely versatile and can be used in a number of system configurations. It is fully magnetically shielded and can be positioned as close to a TV as you wish. On it's own it can be used in a two-channel stereo system for use in a small room, or to provide background music in a kitchen or bedroom. Alternatively the Radius 90 can be used as part of a Home Theatre system or multi-channel audio set-up. The Radius 360 or 720 subwoofers can be used with the Radius 90 to provide deep, powerful bass. Please refer to the section; 'System Wiring Configurations' on page 15.

Grille Fitment

To help the Radius 90 fit into any life-style environment we include a choice of silver and black grilles (silver and white with white Radius 90) as standard. You will find the spare grilles enclosed within the polystyrene packaging end caps.

If you wish to change the grille colour, you can do this by carefully removing the grille, using your fingers to gradually pull the existing grille off the cabinet. To fit a grille, ensure the badge is correctly orientated and gently press the grille into place.

Technical Specification

Frequency Response	Nominal Impedance	Sensitivity (1w@1m)	Maximum SPL	Power Handling Full Range (R.M.S)	System Power Handling (R.M.S)	Recommended Amplifier Requirements
85 Hz – 25 KHz	8Ω	87dB	105dBA	60W	100W	10-100 W

Bass Alignment	Drive Unit Complement Bass	Drive unit Complement Tweeter	External Dimensions (cm)	Weight Kg (each)
Rear ported bass reflex	1 x 4" MMP 2 (Second generation metal matrix polymer)	1 x 25mm C-CAM gold dome tweeter	19 H x 12 W x 14 D	2

RADIUS 180

Positioning

The Radius 180 can be positioned vertically (portrait) or horizontally (landscape). The Radius 180 can be positioned on a shelf by fitting the rubber feet provided to the underside of the speaker to stop vibrations. Alternatively, you can choose to fix the Radius 180 to a wall by using the high-quality metal alloy wall bracket provided, or by purchasing the specially designed bespoke Radius Floor Stand from your local authorised Monitor Audio dealer. To fix your speaker to the wall, please refer to the 'Wall Bracket Fixing Instructions' in the wall bracket carton. When using the wall bracket, we do not recommend connecting the loudspeaker using 4mm plugs into the ends of the terminals. The connection can be made by unscrewing the terminal cap and using the through hole. The terminal cap can be retightened to provide a secure connection.

Configuration

The Radius 180 is extremely versatile and can be used in a number of system configurations. It is fully magnetically shielded and can be positioned as close to a TV as you wish. On its own it can be used in a two-channel stereo system as part of a multi-channel audio/ Home Theatre system. The Radius 360 or 720 subwoofers can be used with the Radius 180 to provide deep, powerful bass. Please refer to the section; 'System wiring configurations' on page 15.

Grille Fitment

To help the Radius 180 fit into any life-style environment we include a choice of silver and black grilles (silver and white with white Radius 180) as standard. You will find the spare grilles enclosed within the polystyrene packaging end caps. If you wish to change the grille colour, you can do this by carefully removing the grille using your fingers to gradually pull the existing grille off the cabinet. To fit a grille, ensure the badge is correctly orientated and gently press the grille into place.

Technical Specification

Frequency Response	Nominal Impedance	Sensitivity (1w@1m)	Maximum SPL	Power Handling Full Range (R.M.S)	System Power Handling (R.M.S)	Recommended Amplifier Requirements
60 Hz – 25 KHz	8Ω	87dB	105dBA	60W	100W	10-100 W
Bass Alignment	Drive Unit Complement Bass	Drive Unit Complement Tweeter	External Dimensions (cm)	Weight Kg (each)		
Front ported bass reflex	1 x 4" MMP 2 (Second generation metal matrix polymer)	1 x 25mm C-CAM gold dome tweeter	35 H x 12 W x 9.5 D	2.3		

Radius 45/90/180 Wall Bracket



WARNING: For safety reasons do not attempt to fix these speakers to your wall if you are unsure of your ability to provide a secure and safe fixing. You will need to determine where to fit the bracket and the structure of the wall. If unsure, please obtain the services of a competent qualified tradesperson.



WARNING: Ensure that there are no water pipes, or electricity cables running behind where the wall bracket is going to be secured. Work from secure steps and avoid trailing wires.

To fix your radius product to its bespoke wall bracket please refer to the fixing instructions found in the Wall Bracket Carton. These instructions give a well detailed approach on fixing the bracket. A template is also provided for assistance.

NOTE: The bracket is NOT ceiling mountable

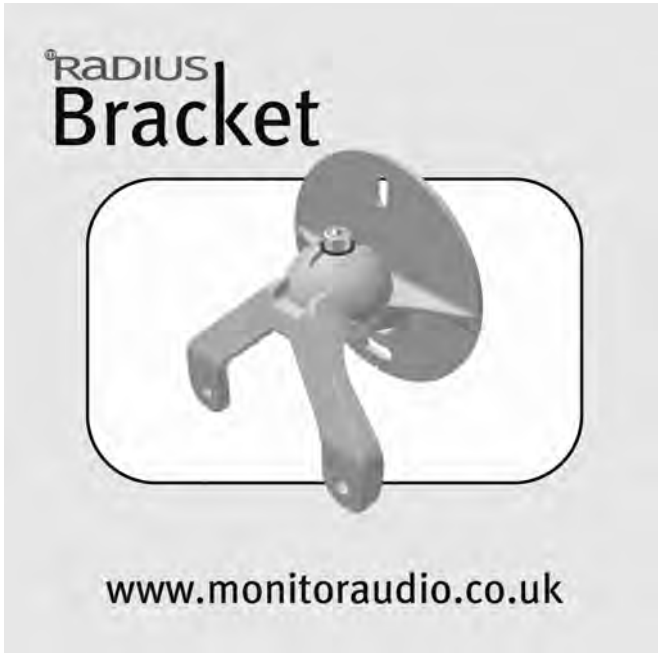

RADIUS 225

Positioning

The Radius 225 can be positioned vertically (portrait) or horizontally (landscape) and has been designed ideally to be used with a plasma TV or in places where space is at a premium. The Radius 225 can be positioned on our bespoke table stand or shelf by fitting the rubber feet provided to the underside of the speaker. Alternatively you can choose to fix the Radius 225 to a wall by using the high-quality bespoke wall bracket provided. Please refer to the 'Radius 225/250 Wall Bracket Fixing Instructions' on page 9. The table will stand the speaker 75mm ($2\frac{15}{16}$ "") off the table.

Configuration

The Radius 225 is fully magnetically shielded and can be positioned as close to a TV as you wish, either as a pair in a two-channel stereo system or as part of a multi-channel audio/ Home Theatre system. The Radius 360 or 720 subwoofers can be used with the Radius 225 to provide deep, powerful bass. Please refer to the section; 'System wiring configurations' on page 15.

Grille Fitment

To help the Radius 225 fit into any life-style environment we include a choice of silver and black grilles (silver and white with white Radius 225) as standard. You will find the spare grille enclosed within the polystyrene packaging trays. We have also included a spare badge. This is for when the Radius 225 is used as a centre channel speaker. If you don't like the factory fitted location of the badge, you can carefully remove this badge and place the enclosed spare badge in your preferred location.

If you wish to change the grille colour, you can do this by carefully removing the grille using your fingers to gradually ease the existing grille off the cabinet. To fit a grille, gently press the grille into place

Technical Specification

Frequency Response	Nominal Impedance	Sensitivity (1w@1m)	Maximum SPL	Power Handling Full Range (R.M.S)	System Power Handling (R.M.S)	Recommended Amplifier Requirements
55 Hz – 25 KHz	8Ω	90dB	108dB	120W	140W	20-120 W
Bass Alignment	Drive Unit Complement Bass	Drive Unit Complement Tweeter	External Dimensions (cm)	Weight Kg (each)		
Front ported bass reflex	2 x 4" MMP 2 (Second generation metal matrix polymer)	1 x 25mm C-CAM gold dome tweeter	61 H x 12 W x 10.5 D	4.2		

RADIUS 250

Positioning

The Radius 250 can be positioned vertically (portrait) or horizontally (landscape) and has been designed ideally to be used with a large plasma TV or in places where space is at a premium. The Radius 250 can be positioned on our bespoke table stand, or shelf by fitting the rubber feet provided to the underside of the speaker. Alternatively you can choose to fix the Radius 250 to a wall by using the high-quality bespoke wall bracket provided. Please refer to the 'Radius 225/250 Wall Bracket Fixing Instructions' on page 9. The table will stand the speaker 75mm ($2\frac{15}{16}$ ") off the table.

Configuration

The Radius 250 is fully magnetically shielded and can be positioned as close to a TV as you wish, either as a pair in a two-channel stereo system or as part of a multi-channel audio/ Home Theatre system. The Radius 360 or 720 subwoofers can be used with the Radius 250 to provide deep, powerful bass. Please refer to the section; 'System wiring configurations' on page 15.

Grille Fitment

To help the Radius 250 fit into any life-style environment we include a choice of silver and black grilles (silver and white with white Radius 250) as standard. You will find the spare grille enclosed within the polystyrene packaging trays. We have also included a spare badge. This is for when the Radius 250 is used as a centre channel speaker. If you don't like the factory fitted location of the badge, you can carefully remove this badge and place the enclosed spare badge in your preferred location.

If you wish to change the grille colour, you can do this by carefully removing the grille using your fingers to gradually ease the existing grille off the cabinet. To fit a grille, gently press the grille into place

Technical Specification

Frequency Response	Nominal Impedance	Sensitivity (1w@1m)	Maximum SPL	Power Handling Full Range (R.M.S)	Recommended Amplifier Requirements
50 Hz – 25 KHz	8Ω	90dB	108dB	120W	20-120 W
Bass Alignment	Drive Unit Complement Bass	Drive Unit Complement Tweeter	External Dimensions (cm)	Weight Kg (each)	
Twin, Front ported bass reflex	2 x 4" MMP 2 (Second generation metal matrix polymer)	1 x 25mm C-CAM gold dome tweeter	76 H x 12 W x 10.5 D	4.3	

Radius 225/250 Wall Bracket Fixing Instructions

 **WARNING:** For safety reasons do not attempt to fix these speakers to your wall if you are unsure of your ability to provide a secure and safe fixing. You will need to determine where to secure the brackets and the structure of the wall. If unsure, please obtain the services of a competent qualified tradesperson.

 **WARNING:** Ensure that there are no water pipes, or electricity cables running behind where the wall bracket is going to be secured. Work from secure steps and avoid trailing wires.

The Radius 250 is fitted with two ¼ UNC inserts. These can be found under the factory fitted wall brackets. These inserts have been put in place for use with other after market wall brackets.

For detailed information on fixing your Radius 225/ 250 to the wall, please refer to the fixing instruction found in with the Wall Fixing Plate.

For alternate fixing please use the fixing template.

Radius 225/ 250 Table Stand

Sold in pairs in black or silver

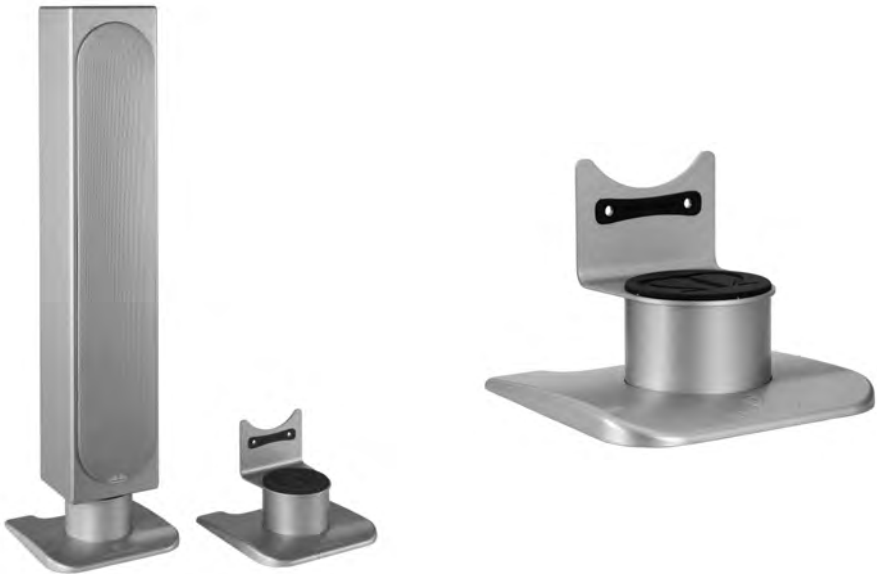

RADIUS 270

Positioning

The Radius 270's are the only floor standing loudspeaker in the Radius line up. These excellent performing floor-standers, come ready to play straight out of the box with stabilizing plinths already attached (we do not recommend that you take this plinth off). To improve the bass response you can fit the acoustic spikes to the underside of the plinths. These simply screw in to the remaining four holes in the bottom of each plinth. Caution must be taken when handling the spikes as they are very sharp. The Radius 270's should be positioned no closer than 2 – 2.5 metres apart for optimum sound.

Configuration

The Radius 270's can be used in a number of system configurations. They are fully magnetically shielded and can be positioned as close to a TV as you wish. On their own they can be used in a two-channel stereo system for use in a medium size room. Alternatively the Radius 270's can be used as part of a Home Theatre system or multi-channel audio set-up. The Radius 360 or 720 subwoofers can be used with the Radius 270's to provide deep, powerful bass. Please refer to the section; 'System Wiring Configurations' on page 15.

Grille Fitment

To help the Radius 270's fit into any life-style environment we include a choice of silver and black grilles (silver and white with white Radius 270's) as standard. You will find the spare grilles enclosed within the polystyrene packaging end caps. The spare grille with the badge should be used on the bottom bass driver of each cabinet. However this is not essential. You can change them to the mid bass units if you so wish.

If you wish to change the grille colour, you can do this by carefully removing the grille, using your fingers to gradually pull the existing grille off the cabinet. To fit a grille, ensure the badge is correctly orientated and gently press the grille into place.

Technical Specification

Frequency Response	Nominal Impedance	Sensitivity (1w@1m)	Maximum SPL	Power Handling Full Range (R.M.S)	System Power Handling (R.M.S)	Recommended Amplifier Requirements
50 Hz – 25 KHz	8Ω	89dB	107.5dBA	120W	140W	40-140 W
Bass Alignment	Drive Unit Complement Bass	Drive Unit Complement Tweeter	External Dimensions (cm)	Weight Kg (each)		
Front ported bass reflex	2 x 4" MMP 2 (Second generation metal matrix polymer)	1 x 25mm C-CAM gold dome tweeter	92.5 H (inc Plinth) x 12 W x 14 D Plinth: 18.5 x 18.5	8		

RADIUS 360 & RADIUS 720

WARNING

- TO PREVENT FIRE OR SHOCK HAZARD, DO NOT USE THIS PLUG WITH AN EXTENSION CORD, RECEPTACLE OR OTHER OUTLET UNLESS THE BLADES CAN BE FULLY INSERTED TO PREVENT BLADE EXPOSURE
- TO PREVENT FIRE OR SHOCK HAZARD, DO NOT EXPOSE THIS APPLIANCE TO RAIN OR MOISTURE
- TO PREVENT ELECTRIC SHOCK, MATCH WIDE BLADE PLUG TO WIDE SLOT FULLY INSERT.



This lightning flash with an arrow head symbol, within an equilateral triangle, is intended to alert the user to the presence of un-insulated “dangerous voltage” within the products enclosure that may be of sufficient magnitude to constitute a risk of electric shock to the persons.



Warning: To reduce the risk of electric shock, do not remove cover (or back), no user-serviceable parts inside. Refer servicing to qualified service personnel.



This exclamation point within an equilateral triangle is intended to alert the user to presence of important maintenance (servicing) instructions in the literature accompanying the appliance.

Unpacking & Installation



WARNING: The Radius 720 is very heavy, and we recommend this being a two person lift only.

Remove the clear plastic, bass driver transit protection disk(s). It is important to position the subwoofer initially to have easy access to the control panel. Make sure all your cables will reach easily and leave the Radius 360/720 unplugged from the mains electricity supply, until the installation and initial set-up procedure is complete.

The optimal control settings will ultimately depend entirely on your system configuration. For initial trials set the controls as follows:

Volume - Should be set to the minimum position.

Frequency - Should be set to approximately 100 Hz.

Phase - Should be set initial to 0 degrees.

Mode (R360 only) - If you are setting your system up as two channel, set the mode switch in “music” mode. If you are installing a predominately home cinema system it may be more effective to set mode switch to “movies” position.

Crossover/LFE (R720 only) – If your subwoofer is being used with a stereo integrated/pre/power amplifier, this should be set to ‘crossover’. If your subwoofer is being used with an AV amp/receiver with a dedicated subwoofer output, this should be set to ‘LFE.’.



WARNING: Do not adjust the main voltage selector, as this is factory pre-set.

Position/Location

Your Radius 360/720 Subwoofer is magnetically shielded and can be located in close proximity to a T.V. No matter where you place your Radius 360/720, you must allow sufficient spacing for ventilation of the rear panel. We recommend this distance to be not less than 100mm (4”).

Subwoofer Connections

There are a number of ways to connect your subwoofer into your system. One uses loudspeaker cables; the other uses interconnect cables with RCA phono plugs. Looking at the rear panel of your subwoofer you will see two sets of speaker terminals, one labelled ‘amplifier input’, the other ‘speaker output’, and RCA phono sockets labelled ‘input’ (right and left).

Please refer to the section; ‘System Wiring Configuration’ on page 15.

If you have a Radius 720, and wish to connect more than one subwoofer, you can do this by using the RCA phono output connectors on the amplifier to ‘daisy chain’ the subwoofers together.

Radius 360/720 Features

1. Power Switch with Auto off Facility: The power switch has two positions: Off - Auto On. In the Auto On position the sub-woofer unit will remain in standby mode until the unit receives an input signal (greater than 4mV). If the subwoofer unit does not receive a signal within 15-20 minutes, it will switch to standby mode until it receives a further signal.

2. Mode Switch (R360 only): This facility is used to set the desired frequency contour for music or home cinema system.

3. Volume: This control allows the subwoofer level or loudness to be adjusted in order that you can achieve a totally controlled balanced sound.

4. Frequency: This feature controls the upper frequency limit of the Radius 360/720.

5. Phase: The phase control is used to synchronise the output between the Radius 360/720 and main/satellite speakers. For most applications this should be set to 0 degrees.

6. Crossover/LFE Switch (R720 only): This switch allows the internal low pass crossover to be enabled or by-passed. Under normal operating conditions (using a stereo amplifier) the switch should be set to ‘crossover’. This allows the frequency control to be adjusted. If an AV amp/receiver is being used, the switch should be set to LFE. This enables the subwoofer’s crossover point to be determined by the AV amp/receiver.

NOTE: In LFE mode, the frequency control will not work.

7. RCA Phono Input Connection: This method of connection is recommended where a pre-amplifier or home theatre processor/ receiver is to be used.

8. RCA Phono Output Connection (R720 only): The line level output is provided so that other subwoofers can be connected to the system in a ‘daisy chain’ type connection. This may be necessary in very large rooms.

9. Amplifier Input: This facility provides the Radius 360/720 with connection directly from the amplifier output terminals (speaker level).

10. Speaker Output: This provides output to satellite speakers via a built in high pass filter.

11. The Mains Fuse: This should be replaced with one of identical specification. Note: A spare fuse is provided within the fuse holder, located in the plastic holder below the IEC mains input socket. If a fuse blows more than once, it is advisable to have the subwoofer unit checked by an authorised service agent.

12. Mains Voltage Selector: This is factory set to your countries mains voltage specification. Do not attempt to adjust this as this may lead to permanent damage to the product and even the risk of fire.



Technical Specifications

Radius 360

Frequency Response	Phase control	Frequency Control	Bass Alignment	Drive Unit Complement Bass
27 Hz – 180 Hz	0 - 180 degrees	Variable 40 Hz - 180 Hz	Downward Ported Bass Reflex With HiVe® Technology	1 x 8" Ultra long throw sub bass driver. Hand treated paper cone woofer
External Dimensions (cm)	High Pass Filter (speaker level output)	Mains Power input (switchable)	Power Output	Weight Kg (each)
36.5 H (Inc feet) x 22.5 W x 34 D (Inc amp)	100Hz @ 6dB/octave	110-120v 60Hz 220-240v 50Hz	100W (RMS) @ 4 Ohms	13.9

Radius 720

Frequency Response	Phase control	Frequency Control	Bass Alignment	Drive Unit Complement Bass
25 Hz – 180 Hz	0 - 180 degrees	Variable 40 Hz - 180 Hz Active 2 nd order 12dB/Octave two stage filter	Rear Ported Bass Reflex With HiVe® Technology	2x 8" Ultra long throw sub bass driver. Hand treated paper cone woofer
External Dimensions (cm)	High Pass Filter (speaker level output)	Mains Power input (switchable)	Power Output Digital Class D Amplifier	Weight Kg (each)
45.5 H (Inc feet) x 22.5 W x 48 D (Inc amp)	100Hz @ 6dB/octave	110-120v 60Hz 220-240v 50Hz	250W (RMS) @ 4Ohms	20.1

Fine-tuning

1. Connect the mains supply and switch on the Radius 360/720. Play the music/movie at an average listening level; the Subwoofer should switch on automatically (blue LED on front will illuminate)
2. The volume control can now be adjusted to a desirable level.
3. The frequency control can now be set to give a seamless sound balance. The setting will depend on the low frequency response of the main/satellite speakers.
4. The volume may need to be fine-tuned to complete the installation process. It is very important to try a variety of music/movies with which you are familiar in order to obtain the optimum overall settings.

Troubleshooting

No sound from the subwoofer

- Check that the power connection is made correctly.
- Check to see if the power light is on.
- Check the input connections to the subwoofer are correct.
- If the amplifier input is in use, check the connections are phased correctly (+ to + and - to -).
- If the amplifier input is in use, check the speaker wires are connected at the amplifier.

Excessive bass from subwoofer

- Check the position of subwoofer - ensure that it is not too close to a corner of the room
- Re-check the set-up procedure

Inadequate bass from subwoofer

- Re-check full set-up procedure

Vibrating noise from subwoofer

- Check that this is not caused by items located on top of or close to the Subwoofer, which may vibrate when subject to deep bass sounds

If problems persist contact your dealer for assistance.

System wiring configuration

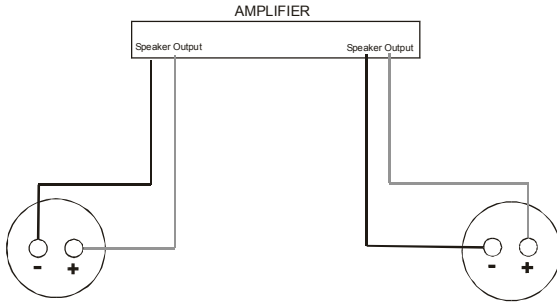

The illustration to the left shows how the Radius 90, 180, 225, 250 and 270 can be connected direct to your amplifier. We do not recommend using the Radius 45 with a normal 2 channel stereo system.

This next illustration to the right shows how the high pass filter is used on the Radius 360/720 sub-woofer using high-level speaker outputs.

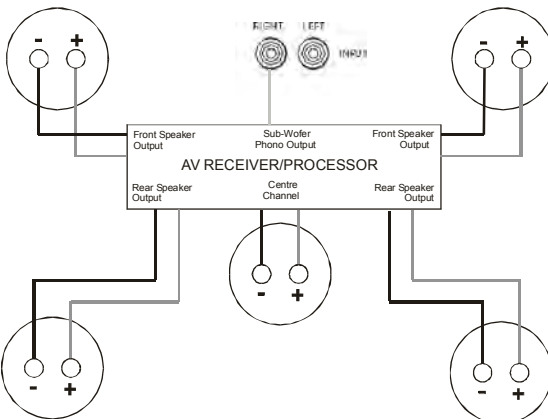
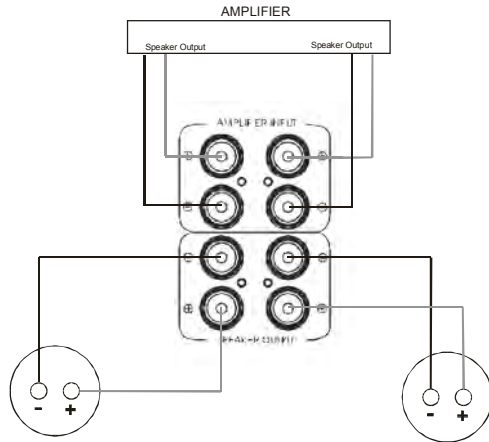

This final configuration to the left shows how the Radius speakers can be used in home cinema. Connect the Radius 45's, 90's, 180's, 225's, 250's or 270's to your AV receiver/processor using the speaker outputs and use the RCA phono sub-woofer output on the receiver/processor and connect to the right input on the Radius 360/720 sub-woofer. **When connecting your Radius loudspeakers to an AV amplifier, please set the amplifier up so that it recognises that they are small speakers. To do this you will need to refer to the AV amplifier's owners manual.**

Ancillary Equipment

All Monitor Audio Radius loudspeakers present an easy, efficient load and are compatible with most good quality amplifiers.

Implementation of the latest design and construction techniques offer equal suitability to the demands of both current and future digital and analogue formats.

Monitor Audio's power handling figures are based upon undistorted speech and music signals.

All Monitor Audio loudspeakers are primarily intended for use in a normal domestic environment. Provided you do not overdrive your amplifier or make excessive use of bass or treble boosts, you should never damage either the amplifier or loudspeakers.

High quality components are utilised to produce these loudspeakers ensuring accurate reproduction of the signal fed to them, so it is important to appreciate that the ancillary equipment used will profoundly affect performance.

If distortion is evident when the volume level is increased this is a sign of overdriving and the volume level should be reduced immediately.

Used properly, loudspeakers will rarely fail and if both units reproduce the same fault or distortion, then it is likely that the problem is elsewhere in the system. In such instances please contact your dealer.

Guarantee and Service

Valid upon completion of the guarantee card and its return within 30 days of purchase.

This equipment has been fully tested prior to dispatch from the factory. Both the craftsmanship and the performance of this product is guaranteed against manufacturing defects for the period of three years (one year for Radius 360/720) from the date of purchase (see conditions below), provided that the product was supplied by an authorised Monitor Audio retailer under the consumer sale agreement.

(The words 'consumer sale' shall be construed in accordance with Section 15 of the supply of goods act 1973).

Monitor Audio accepts no responsibility for defects arising from accident, misuse, abuse, wear and tear, modification or operation outside of that specified within this manual. Neither will responsibility be accepted for damage or loss occurring during transit to or from the parties claiming under this guarantee.

This guarantee covers both labour and parts. The liability of Monitor Audio is limited to the cost of repair or replacement of the defective parts (at the discretion of Monitor Audio) and under no circumstances extends to consequential losses or damage.

Service

The user should not attempt to service their Radius loudspeakers beyond that specified in this manual. Qualified service personnel should carry out all other servicing requirements.

Claims under this Guarantee

The equipment should be returned in its packaging to the original supplier where possible, or to any other authorised Monitor Audio dealer. If it is not possible to return the equipment by hand, then it should be sent carriage prepaid via a reputable carrier. If the original packing is not available replacement packaging can be purchased from Monitor Audio. If you have any difficulties complying with these requirements please contact us at the following address:

Monitor Audio Ltd.
Unit 2, 24 Brook Road
Rayleigh
Essex
SS6 7XL
England

Tel: 44 (0) 1268 740580
Fax: 44 (0) 1268 740589
Internet: www.monitoraudio.co.uk
Email: info@monitoraudio.co.uk

This guarantee does not affect the statutory rights of the consumer under UK law. Monitor Audio reserve the right to alter specifications without notice if it is considered that an improvement can be made to the product.